

1

2

A

A

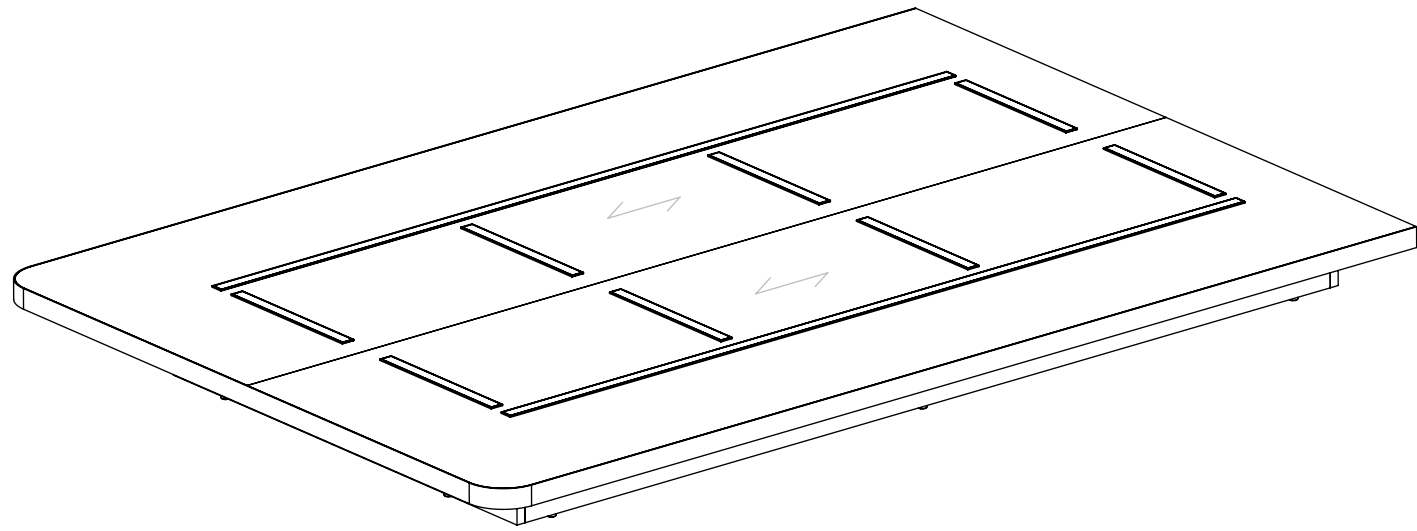

B

B

**Overall:**  
54"W x 80"D x 7"H

**MATERIALS:**  
 - HP-Laminate PB-3/4"  
 - 2mm Edge Tape On Top  
 - White Oak Molding Support  
 - Bottom Plastic Nail Glide  
 - Anti-Slip Tape

**COMMENTS:**  
 - Overall: 54"W x 80"D x 7"H  
 - Color: Wilsonart - 8213K-18 - Phantom Cocoa  
 - Note: Dimensional Tolerance +/- 1/16"

**TITLE:** AHB 8240XX 4ABB - 8240CRS - ADA Full Bed Base  
**REVISION DATE:** 4/7/2022

NOTE: DESIGN AND DRAWINGS ARE PROPERTY OF DICKSON FURNITURE MANUFACTURERS LLC AND MAY NOT BE DUPLICATED OR REPRODUCED WITHOUT THE EXPRESS WRITTEN CONSENT OF DICKSON FURNITURE MANUFACTURERS LLC

QUANTITY  
**00**

REV  
**A**

DIMENSIONS  
ARE IN  
INCHES

**DICKSON**  
FURNITURE MANUFACTURERS

SCALE: 1:13  
SHEET 1 OF 5

1

2

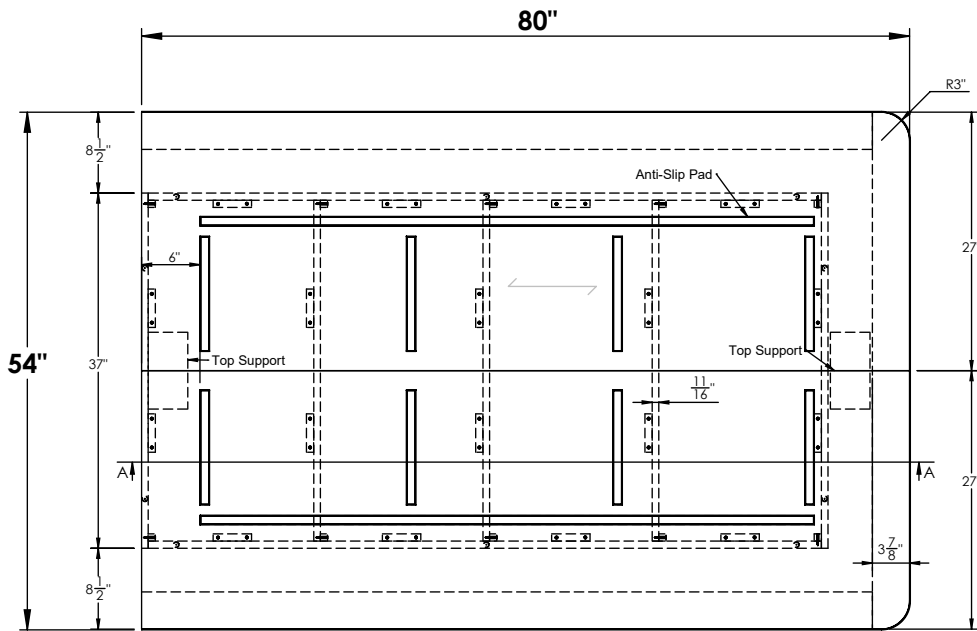

TOP VIEW

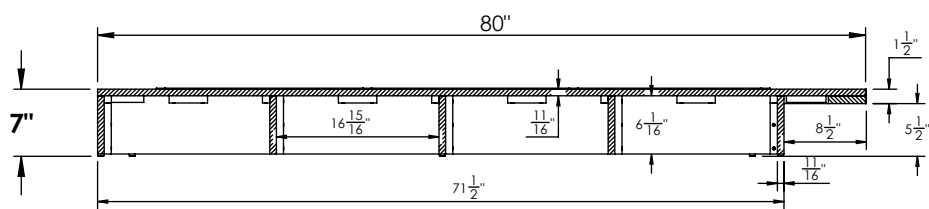

SECTION A-A

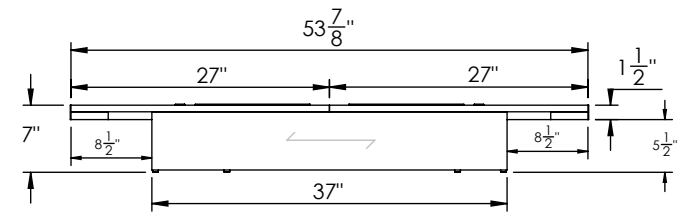

FRONT VIEW

- MATERIALS:
- HP-Laminate PB-3/4"
  - 2mm Edge Tape On Top
  - White Oak Molding Support
  - Bottom Plastic Nail Glide
  - Anti-Slip Tape

- COMMENTS:
- Overall: 54"W x 80"D x 7"H
  - Color: Wilsonart - 8213K-18 - Phantom Cocoa
  - Note: Dimensional Tolerance +/- 1/16"

TITLE: AHB 8240XX 4ABB - 8240CRS - ADA Full Bed Base  
 REVISION DATE: 4/7/2022

NOTE: DESIGN AND DRAWINGS ARE PROPERTY OF DICKSON FURNITURE MANUFACTURERS LLC AND MAY NOT BE DUPLICATED OR REPRODUCED WITHOUT THE EXPRESS WRITTEN CONSENT OF DICKSON FURNITURE MANUFACTURERS LLC

QUANTITY <b>00</b>	REV <b>A</b>	DIMENSIONS ARE IN INCHES	<b>DICKSON</b>
			FURNITURE MANUFACTURERS
		SCALE: 1:18	
		SHEET 2 OF 5	



# IMPORTANT INFORMATION

- AHB 8240XX 4ABB - 8240CRS - ADA Full Bed Base -



Lift parts with at least 2 people

## +RECOMMENDATIONS:

- Read instructions before installing
- Keep area clean
- Do not drag the parts
- Do not forget to wear PPE

## +PERSONAL PROTECTION EQUIPMENT (PPE)

- Hand Protection
- Eye Protection
- Waist Support Belt

## Parts:

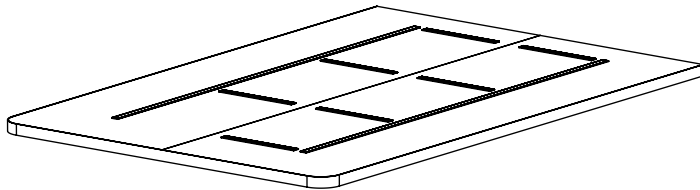

Top Panels

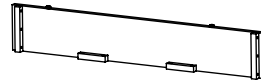

Front Panel

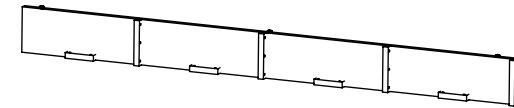

Side Panels (2)

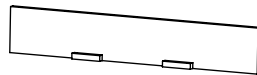

Center Panels (3)

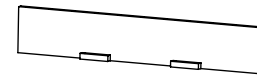

Back Panel

## +Tools:



Measuring Tape



Pencil



Electric screwdriver

## +Hardware:



Screw

# DICKSON

FURNITURE MANUFACTURERS

# STEP #1

# ASSEMBLY INSTRUCTIONS

- AHB 8240XX 4ABB - 8240CRS - ADA Full Bed Base -

Note: For best results, bed should be built starting with the top side face down.

## 1

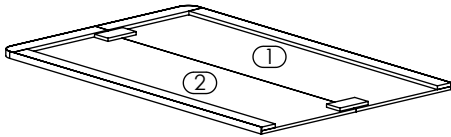

Place Top Panels ① ② upside down on Floor.

## 2

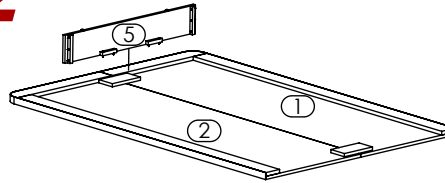

Place Front Panel ⑤ on Top Panels ① ②.

## 3

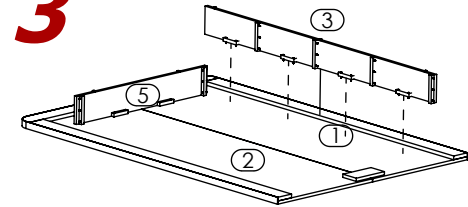

Place Side Panel Right ⑤ on Top Panels ① ②.

## 4

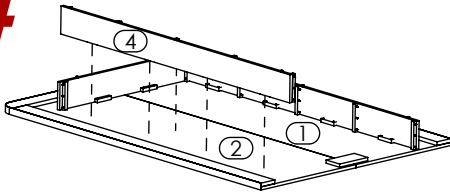

Place Side Panel Left ④ on Top Panel ① ②.

## 5

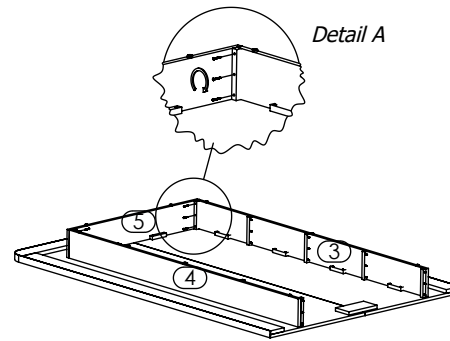

Align and attach Front Panel ⑤ to Side Panel Right ③ then Panel Left ④. (Reference Detail A).

## 6

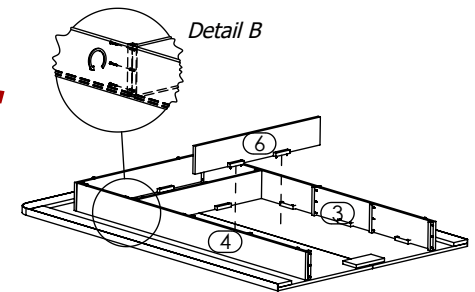

Insert Center Panels ⑥, align & attach to Side Panels ③ ④. (Reference Detail B).

## 7

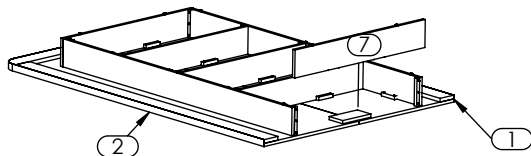

Align Flush the Back Face of Back Panel ⑦ and Top Panels ① ②.

## 8

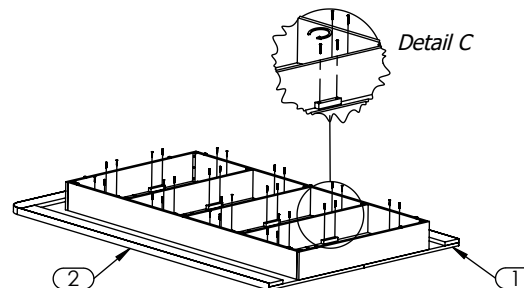

Align assembled Bed Base to taped guides on Top Panel ① and attach them. (Reference Detail C).

# DICKSON

FURNITURE MANUFACTURERS

